



Thank you for purchasing this Neutronics Inc. product. Proper registration will enable us to send you periodic notification of product updates and other important announcements. Registering your product will also allow us to contact you in the unlikely event that it will need adjustment or modification. Please take the time to register your new product at our web site:

<http://www.neutronicsinc.com/productregistration>

You will find the product serial number inside of the battery cover of the main unit and on the outside of the carton box.

If you would like to register by phone, have any operational questions regarding your new purchase, find the location of the distributor in your area, or for any other questions, please call 800-378-2287 (in PA: 610-524-8800).

Thank You.



456 Creamery Way, Exton, PA 19341

Phone: 610.524.8800 • Fax: 610.524.8807 • Email: [info@neutronicsinc.com](mailto:info@neutronicsinc.com)  
[www.neutronicsinc.com](http://www.neutronicsinc.com)





***ULTIMA ID™***  
REFRIGERANT IDENTIFIER  
**OPERATION MANUAL**

Manual Part Number: 5-06-7000-65-0  
Manual File MN-A-0117 Rev. D

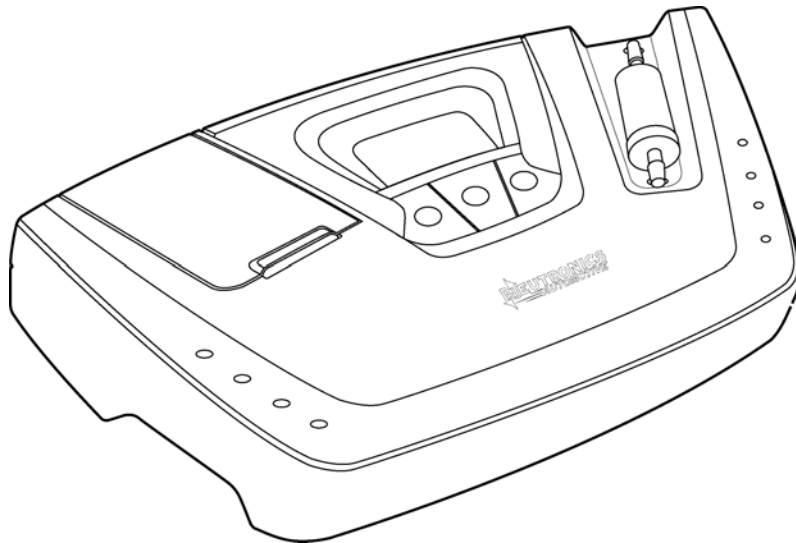

456 Creamery Way, Exton, PA 19341  
Phone: 610.524.8800 • Fax: 610.524.8807 • Email: [info@neutronicsinc.com](mailto:info@neutronicsinc.com)  
[www.neutronicsinc.com](http://www.neutronicsinc.com)



# Table of Contents

TABLE OF CONTENTS .....	III
FOR YOUR SAFETY: .....	V
IDENTIFIER WARNINGS.....	V
GENERAL CAUTIONS .....	VI
WELCOME .....	VII

## 1

### INTRODUCTION AND OVERVIEW ..... 1-9

1.1	GENERAL .....	1-9
1.2	FEATURES .....	1-10
1.3	ULTIMA ID COMPONENTS .....	1-11
1.3.1	Ultima ID Base Unit.....	1-11
1.3.2	R134a Sample Hose.....	1-11
1.3.3	R12 Sample Hose .....	1-12
1.3.4	R134a Tank Adapter Fitting .....	1-12
1.3.5	Vehicle Power Cable .....	1-12
1.3.6	Control Panel .....	1-13
1.3.7	Back Panel Connections .....	1-13
1.3.8	Hard Shell Storage/Carrying Case .....	1-14

## 2

### ULTIMA ID OPERATION ..... 2-1

2.1	FIRST USE .....	2-1
2.1.1	Battery Installation (Optional).....	2-1
2.2	TURNING ON THE UNIT .....	2-2
2.3	CALIBRATION.....	2-2
2.4	VIEWING THE TEST RESULTS .....	2-3
2.5	BLEND REFRIGERANTS.....	2-5
2.6	PRINTING THE TEST RESULTS .....	2-5

## 3

### MAINTENANCE & TROUBLESHOOTING ..... 3-6

3.1	SETTING THE ELEVATION .....	3-6
3.2	SETTING THE LCD CONTRAST .....	3-6
3.3	CHANGING THE SAMPLE FILTER.....	3-7

3.4	CLEANING THE SAMPLE HOSES .....	3-8
3.5	CHANGING THE PRINTER PAPER .....	3-8
3.6	LOW BATTERY WARNING.....	3-9
3.7	ERROR MESSAGES.....	3-9

# 4

APPENDICES.....	4-10
-----------------	------

4.1	SPARE PARTS LIST .....	4-10
4.2	APPENDIX B - SPECIFICATIONS.....	4-10
4.3	APPENDIX E – WARRANTY .....	4-11



## For Your Safety:

**PLEASE READ THIS MANUAL IN ITS ENTIRETY BEFORE ATTEMPTING INSTALLATION OR OPERATION! Attempting to operate the Ultima ID without fully understanding its features and functions may result in unsafe conditions**

- Always use protective eye wear and observe proper safety procedures when working with pressurized gases.

**Read and understand the entire manual BEFORE attempting to operate the instrument.**

## Identifier Warnings

- **Refrigerant Blend Warning:** As of January 2004, there are twelve (12) EPA SNAP “acceptable for use” refrigerants that are available and legal for use as R12 substitutes. The Ultima ID will not identify any of the substitutes as pure R12 or pure R134a. Each of the twelve blends has been tested in the factory laboratory and it has been confirmed that the substitutes will not “fool” the instrument. Should one of the blends be encountered, the instrument will fail the refrigerant and provide a readout of analysis in terms of percentage by weight concentrations of R12, R134a, R22 and hydrocarbons only. Due to cross sensitivity issues of the blends on the sensing device, the resultant reading will not be correct in the analyzed concentrations. However, the Ultima ID will never identify any of the blends as pure R12 or pure R134a.
- **Sample Filter Warning:** Replace the sample filter of the instrument AS SOON AS RED SPOTS OR DISCOLORATION BEGIN TO APPEAR ON THE OUTSIDE DIAMETER OF THE WHITE ELEMENT. Failure to properly maintain and replace the sample filter will result in severe damage.
- **Sample Input Warning:** The instrument requires connection of the supplied sample hose to the LOW SIDE OR VAPOR port of refrigerant storage cylinders or vehicle air conditioning systems. DO NOT attempt to introduce liquid or samples heavily laden with oil into the instrument. DO NOT connect the sample hose to the HIGH SIDE or LIQUID port!
- Liquid or oil laden samples will cause severe damage to the instrument that will not be covered under warranty repairs.
- **Battery Charger Warning:** When charging the battery with the 1000mA charger, the charger will become warm. If the charger becomes hot, unplug the charger immediately! When charging multiple battery packs, allow the charger to cool between each battery.

## General Cautions

- Always inspect the sample hose before each use. Replace the hose if it appears cracked, frayed, obstructed or fouled with oil.
- ALWAYS turn the compressor or automobile engine off before connecting the instrument to an air conditioning system.
- Always wear eye and skin protection when working with refrigerants. Escaping refrigerant vapors will present a freezing danger.
- To reduce the risk of electrical shock, do not disassemble the instrument; do not use the instrument in wet or damp areas.
- DO NOT direct refrigerant vapors venting from hoses towards the skin.
- DO NOT disassemble the instrument. There are no serviceable components internal to the instrument and disassembly will void the warranty.
- ALWAYS place the Identifier on a flat and sturdy surface.
- DO NOT utilize any other hose other than those supplied with the instrument. The use of other hose types will introduce errors into the refrigerant analysis and instrument calibration.
- ALWAYS verify that the refrigerant to be tested does not contain or will not emit heavy loads of oil or liquid.
- NEVER admit any sample into the instrument at pressures in excess of 300 psig.
- DO NOT utilize the coupler supplied on the service end of the R134a Sample Hose for any application other than with the instrument. The coupler supplied is a modified version that does not contain a check valve and is not suitable for any other refrigerant application.
- NEVER obstruct the air intake, sample exhaust or case vent ports of the instrument during use.



# WELCOME

## Thank you for purchasing the ULTIMA ID Refrigerant Identifier.

The Ultima ID is the most advanced refrigerant identifier ever designed for determining the purity of gaseous automotive refrigerants. It has many features to offer the user, which will be described in this manual. We recommend that all personnel who use this instrument read this manual to become more familiar with its proper operation.

For further information regarding the application, operation or spare parts, please contact the Neutronics Inc. Customer Service Department. If you have questions or comments, we would like to hear from you.

**Neutronics Inc.**

**456 Creamery Way**

**Exton, PA 19341**

**Tel: 610) 524-8800**

**Toll Free: (800) 378-2287 (US only)**

**Fax: (610) 524-8807**

**EMAIL: [info@neutronicsinc.com](mailto:info@neutronicsinc.com)**

**Visit us at [www.neutronicsinc.com](http://www.neutronicsinc.com)**

**Copyright ©2004 Neutronics Inc.**

This work is protected under Title 17 of the US Code and is the sole property of Neutronics Inc. No part of this document may be copied or otherwise reproduced, or stored in any electronic information retrieval system, except as specifically permitted under US copyright law, without the prior written consent of Neutronics Inc.



# 1

## INTRODUCTION AND OVERVIEW

### 1.1 General

Contamination of refrigerants either in storage cylinders or vehicle air conditioning systems can lead to component corrosion, elevated head pressures and system failures when utilized by unsuspecting technicians. The ability of the technician to determine refrigerant type and purity is severely hampered by the presence of air when attempting to utilize temperature-pressure relations. The development of various substitute refrigerants further complicates the ability of a technician to identify refrigerant purity based upon temperature-pressure relationships. The substitute refrigerant blends can also introduce a flammability hazard to the technician and the ultimate end user of the vehicle air conditioning system.

The Neutronics Ultima ID Refrigerant Identifier will provide a fast, easy and accurate means to determine refrigerant purity in refrigerant storage cylinders or directly in vehicle air conditioning systems. The instrument utilizes non-dispersive infrared (NDIR) technology to determine the weight concentrations of refrigerant types R12, R134a, R22, as well as, hydrocarbons and air. Refrigerant purity is automatically determined for refrigerants R12 and R134a by the instrument to eliminate human error. Pure refrigerant is defined as a refrigerant mixture that contains 98%, by weight, or greater of either R12 or R134a.

The instrument is supplied complete with a R12 and R134a sample hose, a R134a adapter fitting to permit sampling of ACME ported cylinders, a 12 VDC power cord and all required plumbing housed within a rugged, portable, storage case.

Sample gas is admitted into the instrument through the supplied sample hose and presented to the sensing device. The instrument provides the user with direct percent by weight concentrations of R12, R134a, R22 and hydrocarbons. If the sample is determined to be pure R134a, the instrument will provide a direct readout of the weight percentage of air within the sample. Note that the instrument does not consider air to be a contaminate since it can be removed by most refrigerant recycling equipment. Since air is not considered to be a contaminate, it is possible to read 100% R134a plus 5% air. The instrument only considers the weights of the refrigerant and contaminants in the total mixture for R134a as air contamination in R12 systems causes only minor performance degradation.

The instrument interfaces with the user with an LCD graphic display, status indicator lamps, push button communication switches and an alarm horn. Alarm indications are provided to alert of instrument fault conditions or contaminated refrigerant presence. Direct percent by weight concentrations of the sample refrigerant is provided on the display as well as user directions and prompts. An optional on-board printer (Model RI-2004DXP) is available to print on-the-spot customer confidence receipts.

The Neutronics Ultima ID Refrigerant Identifier will provide the refrigerant technician with absolute knowledge of refrigerant purity and protection against refrigerant contamination and potential flammability.

## 1.2 Features

The Ultima ID Refrigerant Identifier is the most advanced instrument ever manufactured for determining the purity of gaseous refrigerants for the automotive market.

### Features Include:

- Advanced ergonomic design
- Fender friendly resting surface
- Large graphic display with on-screen instructions
- Ultra fast 60 second test time
- Blend-ID software to identify the presence of popular SNAP Approved Blend Refrigerants
- Built in printer option for instant customer confidence receipt
- Internal, rechargeable battery option for cordless operation in any location
- Hard shell carry/storage case

## 1.3 Ultima ID Components

### 1.3.1 Ultima ID Base Unit

The Ultima Id base unit houses the Graphic Display, Infrared Bench, Electrical Connections, and Optional Printer Module. These components require no maintenance, therefore **there are no serviceable components internal to the instrument, and disassembly will void the warranty.**

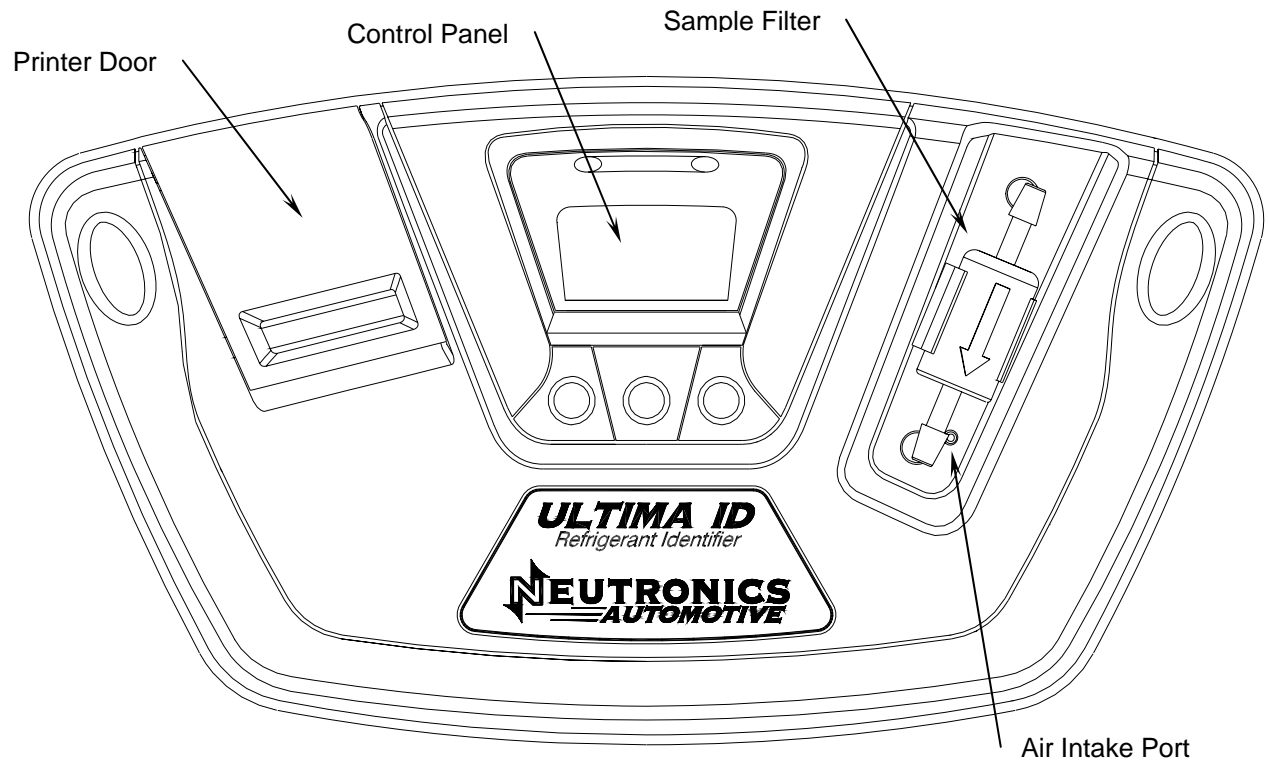

### 1.3.2 R134a Sample Hose

The 6-foot (1.8 meter) R134a Sample Hose is constructed of a nylon inner tube and a polyurethane outer tube. The inner tube will handle all of the refrigerant transfer and will provide containment up to 300 psig. The outer tube will provide protection of the inner tube from abrasion, nicking, cutting, etc. The hose is provided with an instrument inlet port mating connector on one end and the R134a Low Side Coupler on the service end.

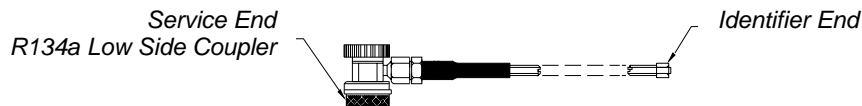

### 1.3.3 R12 Sample Hose

The 6-foot (1.8 meter) R12 Sample Hose is constructed of a nylon inner tube and a polyurethane outer tube. The inner tube will handle all of the refrigerant transfer and will provide containment up to 300psig. The outer tube will provide protection of the inner tube from abrasion, nicking, cutting, etc. The hose is provided with an instrument inlet port mating connector on one end and a ¼" SAE female flare coupling nut on the service end.

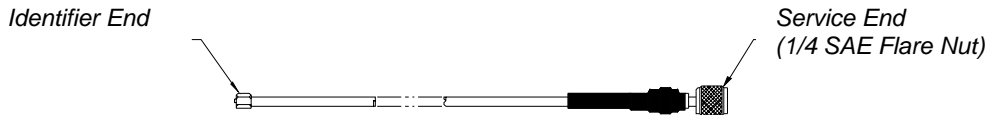

### 1.3.4 R134a Tank Adapter Fitting

The R134a Tank Adapter Fitting will provide the user with an adapter to allow connection of the R134a sample hose service end to a R134a cylinder ACME port.

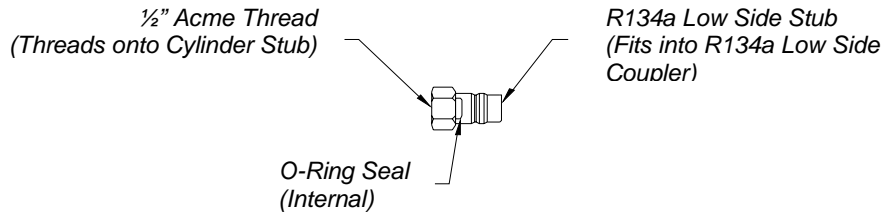

### 1.3.5 Vehicle Power Cable

The Ultima ID is powered from a vehicles 12VDC battery. The Ultima ID power cable is a 6-foot cable that has an instrument mating connector on one end and vehicle battery connection clips on the other end. This harness is utilized to connect power from the vehicle battery to operate the instrument. Note: The vehicle power cable can be used with the optional battery pack installed in the unit. The vehicle power cable will not charge the battery.

### 1.3.6 Control Panel

The Control Panel serves as the main user interface. The Control Panel features three soft key buttons that change their function as the instrument changes modes. The current function for each button is displayed by the soft key label at the bottom of the graphic display. Red and Green LED's at the top of the Control Panel are used for visual Pass/Fail indications.

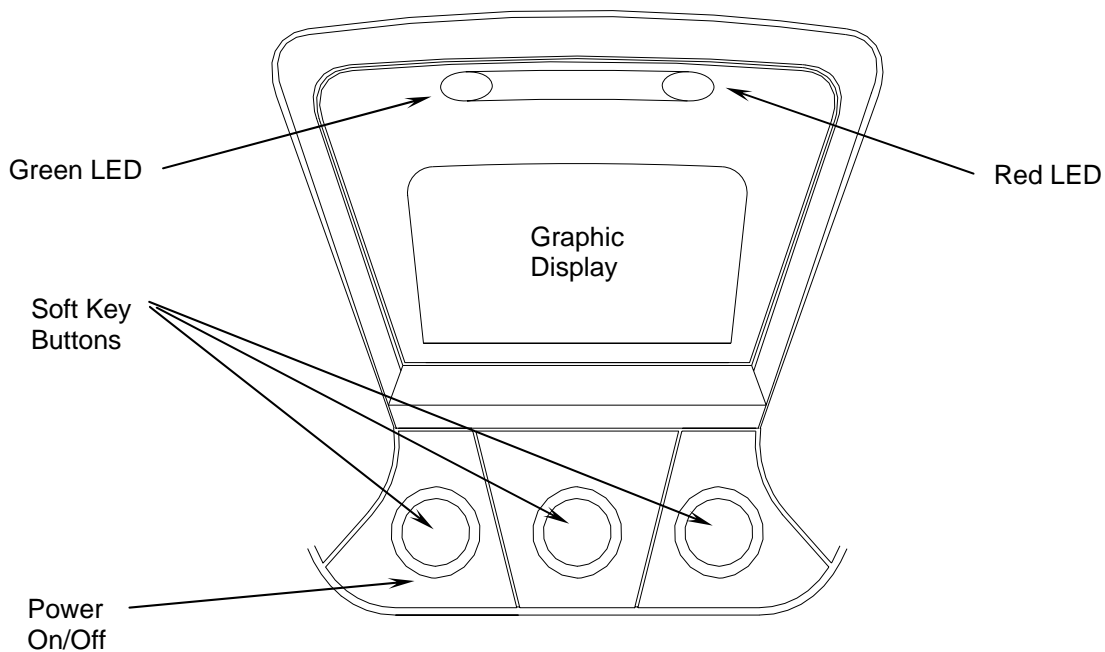

### 1.3.7 Back Panel Connections

The connections located on the back panel are illustrated below.

**CAUTION:** The sample outlet port should never be obstructed. Keep the sample outlet port free and clear at all times.

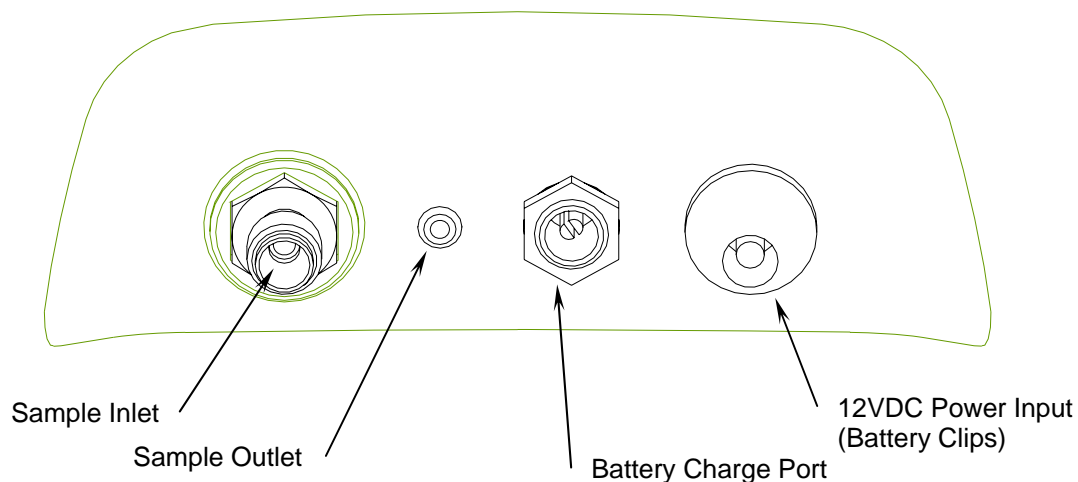

### 1.3.8 Hard Shell Storage/Carrying Case

The hard shell storage/carrying case is custom fit to the Ultima ID. It provides rugged protection for the instrument as well as convenient storage for all components. The enclosure is general purpose and is not watertight.

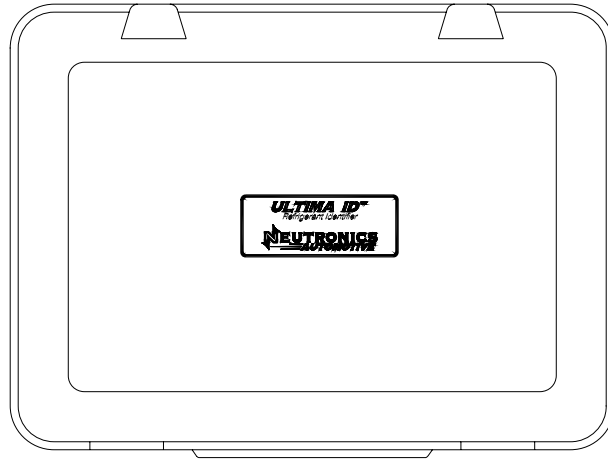



# 2 ULTIMA ID OPERATION

## 2.1 First Use

### 2.1.1 Battery Installation (Optional)

The Ultima ID has, as an option, an internal rechargeable battery. If your Ultima ID is equipped with the optional rechargeable battery, you must first install and charge the battery prior to use. NOTE: The Ultima ID can be operated with or without the battery using the supplied battery clips. Refer to Section 2.2 for instructions.

To install the optional battery, remove the battery cover from the back of the unit by unscrewing the two Phillips head screws as shown below.

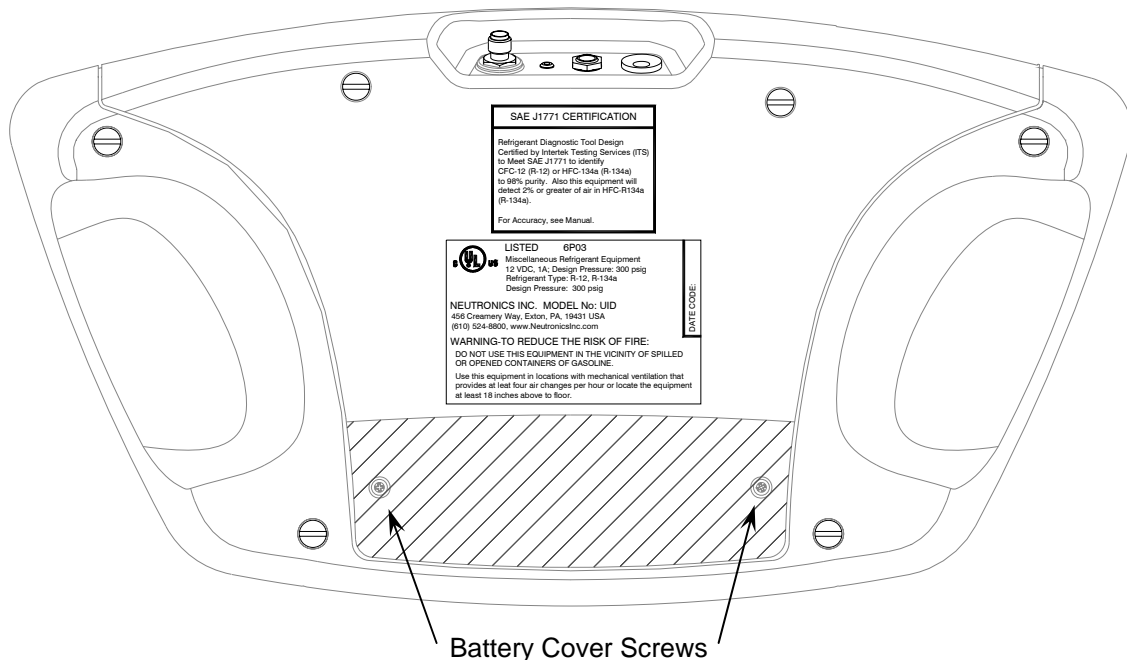

Inside of the Ultima ID battery compartment, locate the male plug on the left side. Slide the nylon strap around the battery. Insert the battery module into the compartment aligning the female connector of the battery module with the male plug in the battery compartment. Replace the cover and snug the screws.

**Note: Charge the battery for a minimum of 4 hours with the supplied charger prior to first use.**

To remove the battery, simply tug gently on the nylon strap, being sure to pull straight up, until the battery is dislodged.

## 2.2 Turning On the Unit

Connect the supplied vehicle power cable to the 12VDC power input jack on the back of the unit. Connect the battery clips to the vehicles 12VDC battery. (Note: If the optional battery module is installed and charged, the vehicle power cable is not required.) Press the left, soft key, power button and the splash screen shown in **Figure 1** will appear for approximately three seconds followed by the elevation screen shown in **Figure 2**. See section 3.1 for details on setting the elevation. Depressing the “DONE” button will bring the Ultima ID to the Calibration screen as shown in **Figure 3**.



Figure 1

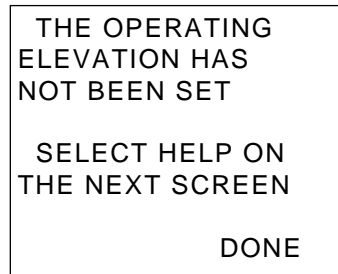

Figure 2

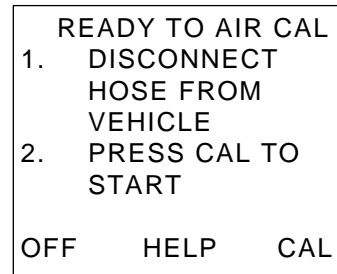

Figure 3

## 2.3 Calibration

Each time the Ultima ID begins a new test cycle it must first self calibrate. The calibration takes 30 seconds (**Figure 4**) and brings fresh air into the unit via an internal pump. This fresh air purges any excess refrigerant from the unit and ensures accurate test results. Calibration requires that the hose be disconnected from the vehicle or refrigerant cylinder. During calibration, the screen shown in **Figure 5** will appear reminding the user to change the filter under certain conditions. For additional details on how and when to change the filter, refer to Section 3, Maintenance and Troubleshooting. The calibration of the unit will expire after approximately five minutes of inactivity. If this occurs, the screen shown in **Figure 6** will be displayed requiring the calibration to be initiated again.

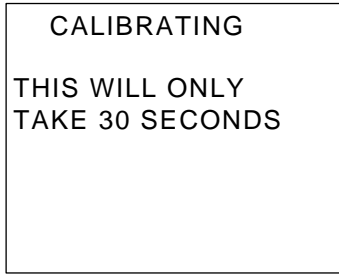

Figure 4

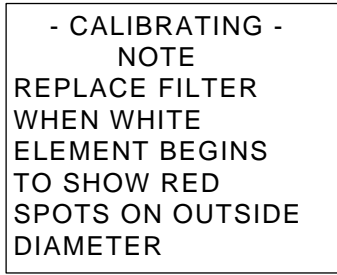

Figure 5

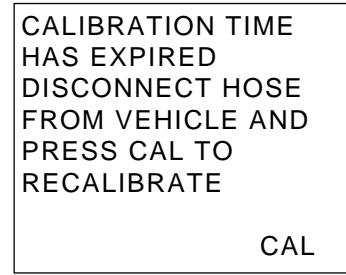

Figure 6

After calibrating, the unit will display the screen shown in **Figure 7**. Connect the hose to the vehicle, (for R134a open the valve) and select the refrigerant type you wish to test. The Ultima ID will display the screen shown in **Figure 8**. If you wish to change any of the factory default settings, refer to section 3.

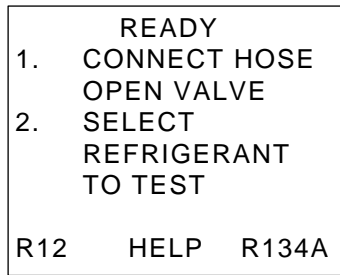

Figure 7

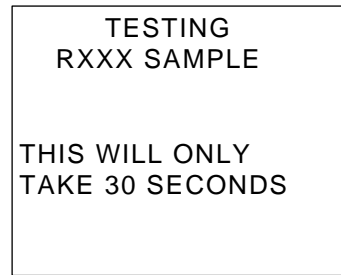

Figure 8

## 2.4 Viewing the Test Results

Upon completion of the test, the Ultima ID will display a screen similar to that shown in **Figure 9** or **Figure 10**.

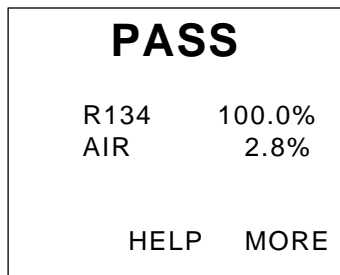

Figure 9

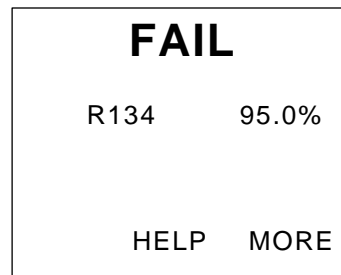

Figure 10

If the refrigerant tested is 98% pure or better, and the air content is less than 10%, the “PASS” screen will display and the Green LED will illuminate. Should the refrigerant be less than 98% pure or the air content greater than 10%, the “FAIL” screen will display and the Red LED will illuminate. In either case, selecting the “MORE” button will display the details in **Figure 11** for “PASS” and **Figure 12** for “FAIL”.

```
RESULTS.....PASS
  R134    100.0%
  R12      .0%
  R22      .0%
  HC       .0%
  AIR      2.8%
EXIT      PRINT
```

Figure 11

```
RESULTS.....FAIL
  R134    95.0%
  R12      5.0%
  R22      .0%
  HC       .0%
EXIT      PRINT
```

Figure 12

## 2.5 Blend Refrigerants

The Ultima ID includes the “Blend ID” feature for determining the presence of EPA S.N.A.P approved blend refrigerants. In the event that the Ultima ID determines that the refrigerant in the system or cylinder is possibly a S.N.A.P. blend, the results will display as follows in **Figures 13, 14, and 15**. Note that pressing the additional “MORE” button on the screen in **Figure 14** will take the user to the Blend Refrigerant screen shown in **Figure 15**. Note: This screen will vary based on the test results.

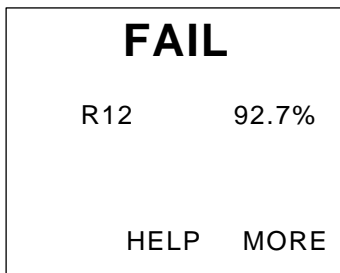

Figure 13

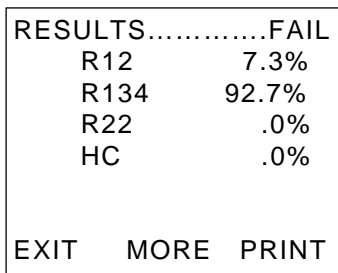

Figure 14

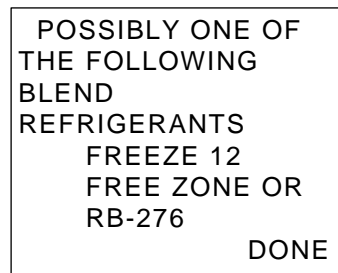

Figure 15

Pressing the “DONE” button in **Figure 15** will return the user to the screen shown in **Figure 14**.

## 2.6 Printing the Test Results

For units equipped with the optional built-in printer module, the test results can be printed by selecting the “PRINT” button. After the print is complete, carefully tear off the printout and the unit will return to the previous screen. Additional printouts may be made following the same procedure. To exit the test, press the “EXIT” button. **Figures 16, 17, 18 and 19**, show sample printouts for various test results.

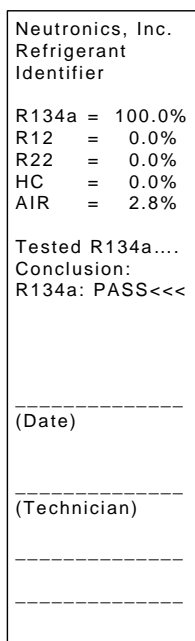

Figure 16

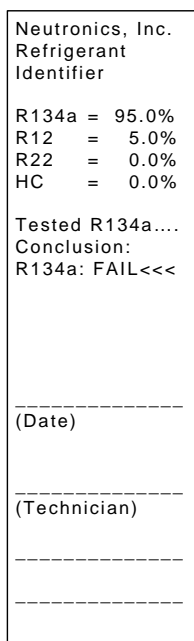

Figure 17

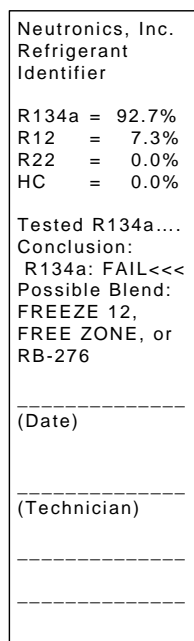

Figure 18

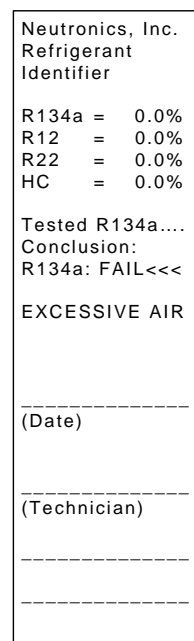

Figure 19

# 3 MAINTENANCE & TROUBLESHOOTING

## 3.1 Setting the Elevation

During the initial power-up, the Ultima ID will indicate that the elevation has not been set. To set the elevation, press the “Help” button on the “Ready to Air Cal” screen as shown in **Section 2.2, Figure 3**. The screen will display several options as shown in **Figure 20**. Pressing the “SET” button will display the options in **Figure 21**.

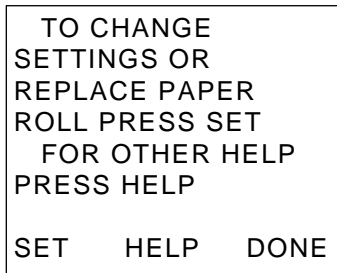

Figure 20

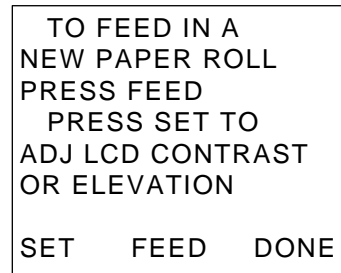

Figure 21

Press the “SET” button shown in **Figure 21** to display the screen options shown in **Figure 22**. Pressing the “ELEV” button will take you the elevation screen shown in **Figure 23**. Use the “UP” & “DOWN” buttons to adjust the unit to the elevation in your area. Press the “SAVE” button when finished to return to the help screen (**Figure 20**).

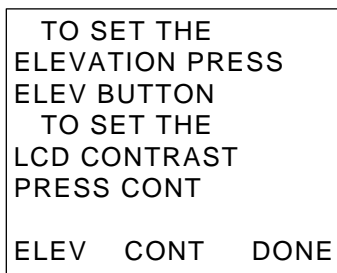

Figure 22

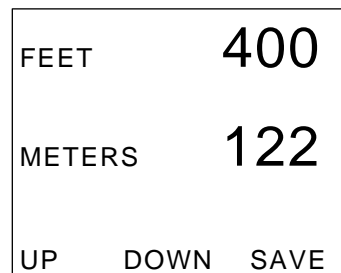

Figure 23

## 3.2 Setting the LCD Contrast

The Ultima ID features an adjustable LCD contrast for use in varying light conditions. To adjust the contrast, press the “HELP” button on the “Ready to Air Cal” screen as shown in **Section 2.2, Figure 3**. The screen will display several options as shown in **Figure 17**. Pressing the “SET” button will display the options in **Figure 18**.

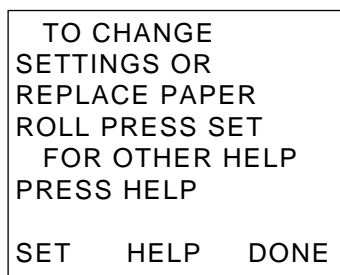

Figure 24

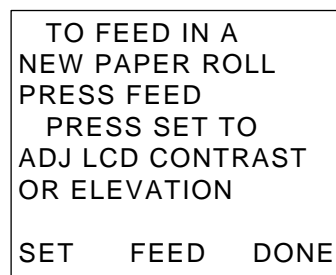

Figure 25

Press the “SET” button shown in **Figure 24** to display the screen options shown in **Figure 25**. Pressing the “SET” button in **Figure 25** will advance the display to **Figure 26**. Pressing the “CONT” button will take you the contrast screen shown in **Figure 27**. Use the “UP” & “DOWN” buttons to adjust the screen contrast for best viewing. Press the “SAVE” button when finished to return to the help screen (**Figure 24**).

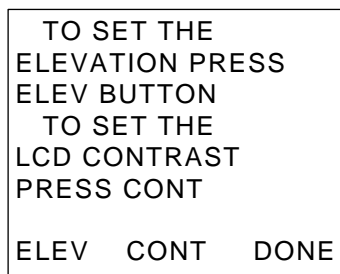

Figure 26

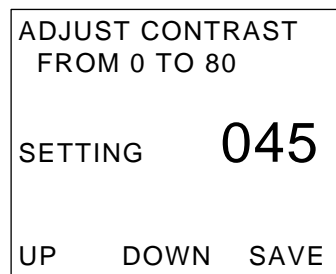

Figure 27

### 3.3 Changing the Sample Filter

When inspecting the sample filter, look completely around the entire outside diameter of the white filter element located inside of the clear plastic housing. Look for red spots or the beginnings of discoloration on the white outside diameter of the element. Do not look into the round ends of the white element for red spots or discoloration. The round ends of the filter may always appear red. If red spots or discolorations are discovered, the sample filter requires replacement to prevent the influx of particulate and oil mists into the instrument.

Obtain a replacement filter, part number 6-02-6000-08-0. Remove the existing filter from the retaining clip of the instrument by pulling straight up and out. CAREFULLY remove the flexible, black rubber tubing connections from both ends of the existing filter. DO NOT allow the tubes to slip back into the internal portion of the case. Discard the existing filter in an environmentally friendly manner.

Install the tube ends onto the barbs of the replacement filter, taking note to align the flow arrow of the filter with the flow arrow of the instrument top panel. CAREFULLY slide the tubing back into the internal portion of the instrument and seat the new filter into the retaining clip. Inspect the sample hoses for signs of oil entrapment. Replacement of the sample filter usually requires cleaning or replacement of the sample hoses.

### 3.4 Cleaning the Sample Hoses

Inspect the inside diameter of the inner tube for signs of oil build up, dirt, obstructions, kinks, cuts, fraying, or any other signs of wear. Oil contamination can be cleaned out of sample hoses as directed below. Hoses that show signs of wear should be replaced immediately to avoid dangers of rupture or bursting.

Remove the hose from the instrument and flush with isopropyl alcohol until the oil is thoroughly cleansed from the inner tube.

**Warning:** Flush hoses away from sparks, open flames or other ignition sources and in an area that is well ventilated.

Dry the hose by blowing clean, dry nitrogen or shop air through the inner hose or by allowing the hose to air-dry for several hours. Take care to not dry the hose with shop air that is lubricated. When the hose is completely dry, re-inspect the hose for signs of wear, as described above, and replace if wear is evident.

### 3.5 Changing the Printer Paper

Ultima ID refrigerant Identifiers that are equipped with on-board printers use an inexpensive thermal paper for printing. The paper roll should be changed when a red stripe appears on the left side of the printout.

To change the paper roll, press the “HELP” button on the “Ready to Air Cal” screen as shown in **Section 2.2, Figure 3**. The screen will display several options as shown in **Figure 28**. Press the “SET” button to advance to the screen shown in **Figure 29** and then press the “FEED” button.

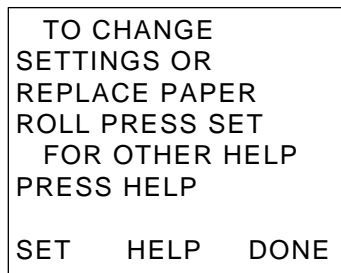

Figure 28

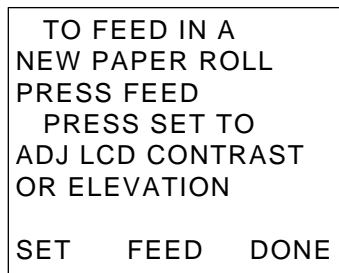

Figure 29

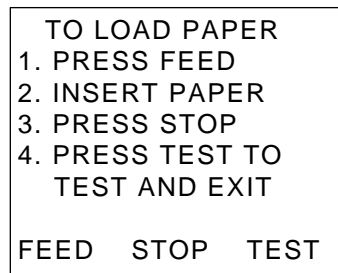
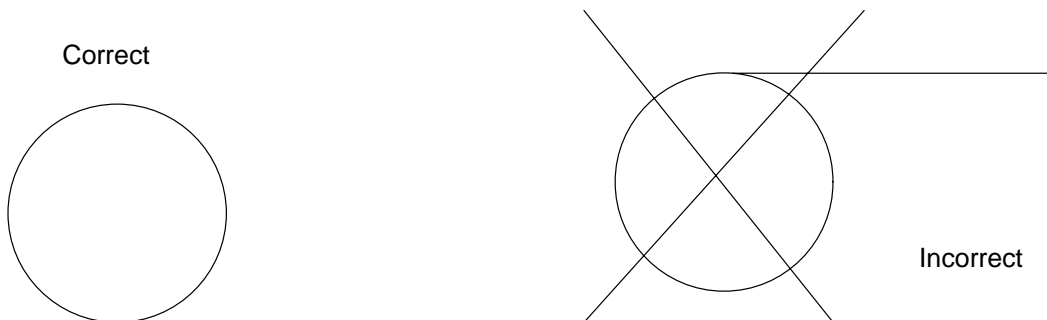

Figure 30

Open the printer door and remove the old roll by tearing the paper as it enters the printer then pressing the “FEED” button shown in **Figure 30** until the old roll exits the printer completely. Insert the new paper roll from the underside as shown below:





Press the “FEED” button shown in **Figure 30** to automatically advance the paper through the printer. When the paper appears on the top of the printer, press the “STOP” button. Press the “TEST” button to print a test message and verify that the paper is installed properly. Slide the paper through the slot in the printer door and close the door.

### **3.6 Low Battery Warning**

For units equipped with the optional rechargeable battery, a “Low Battery Warning” will appear when the battery is nearly exhausted. Several tests may be run after the initial warning however, it is strongly recommended that the unit be recharged or the external battery clips be used.

### **3.7 Error Messages**

In the unlikely event that an “Error” message is displayed on the screen, power off the unit, take it to a location outside of the shop environment where fresh air is available and turn the unit back on. If the “Error” message reappears, contact our service department for assistance.

Neutronics Inc.  
456 Creamery Way  
Exton, PA 19341  
Ph: 800-378-2287 x 123 or 610-524-8800 x 123  
Fax: 610-524-8807

# 4 APPENDICES

## 4.1 Spare Parts List

PART NUMBER	DESCRIPTION
4-03-5004-07-0	R134a Tank Adapter Fitting
6-02-6000-09-0	R134a Sample Hose
6-02-6000-02-0	R12 Sample Hose
6-01-6001-08-0	Vehicle Power Cable
6-02-6000-08-1	Sample Filter (5 Pack)
6-02-6001-04-1	Battery Kit (Optional)
6-02-6001-04-0	Spare Battery
6-01-6001-10-0	Printer Upgrade (Factory Installation Only)
5-03-1000-08-0	Printer Paper Roll (Sold in Quantities of 10 Only)
5-06-7000-65-0	Operating Manual

## 4.2 Appendix B - Specifications

<b>SAMPLE PARAMETERS:</b>	Vapor only, oil-free, 300 psig (2 MPa) Maximum
<b>DETECTED COMPOUNDS:</b>	R12, R134a, R22, Hydrocarbons, Air
<b>SENSOR TECHNOLOGY:</b>	Non-Dispersive Infrared (NDIR)
<b>REFRIGERANT SAMPLE SIZE:</b>	0.3 ounces (8.5 grams) per sample
<b>POWER:</b>	9 – 15 VDC, 2 Amps Maximum
<b>OPERATIONAL TEMPERATURE:</b>	40-130°F
<b>SAE J1771</b>	<p>If the refrigerant being tested is identified as contaminated, any visual percentages displayed of CFC-12 (R-12) or HFC-134a (R134a) outside the design certified value is informational and may not be accurate.</p> <p>This instrument has not been design certified for contaminate detection of R124 or R142b.</p>

### 4.3 APPENDIX E – Warranty

NEUTRONICS warrants, subject to the terms listed below, that the goods will be free from defects in design, materials, and workmanship for a period of (1) one year from the date that the goods are shipped to the buyer.

**THE SOLE LIABILITY OF NEUTRONICS FOR ALL PURPOSES SHALL BE TO REPAIR OR REPLACE, AT THE SOLE OPTION OF NEUTRONICS, DEFECTS APPEARING WITHIN THE (1) ONE YEAR PERIOD. NEUTRONICS SHALL HAVE NO OBLIGATION FOR REPAIR OR REPLACEMENT UNLESS NEUTRONICS HAS RECEIVED WRITTEN NOTICE OF THE ALLEGED DEFECT WITHIN THE (1) ONE YEAR PERIOD AND THE DEFECTIVE GOODS ARE PROMPTLY RETURNED BY THE BUYER, AT THEIR EXPENSE, TO NEUTRONICS AT: 456 CREAMERY WAY EXTON, PA 19341 USA, AND THE DEFECT OCCURS UNDER THE CIRCUMSTANCES OF PROPER USE IN ACCORDANCE WITH ALL INSTRUCTIONS AND MANUALS PROVIDED TO THE BUYER. NEUTRONICS WILL DELIVER THE REPAIRED OR NEW GOODS TO THE BUYER AT NEUTRONICS EXPENSE. IN NO EVENT WILL NEUTRONICS BE LIABLE FOR ANY LOSS OR DAMAGE DIRECTLY OR INDIRECTLY ARISING FROM THE DEFECTS OR FROM THE USE OF THE GOODS OR FROM CONSEQUENTIAL OR INCIDENTAL DAMAGES, WHETHER IN CONTRACT, TORT, OR OTHERWISE, FOR PERSONAL INJURY OR PROPERTY DAMAGE OR ANY FINANCIAL LOSS.**

Buyer shall be responsible for insuring that the goods are functioning properly at all times and shall not use any goods which are not functioning properly. Buyer, therefore, agrees to indemnify NEUTRONICS from and against all losses and claims to or by any person or property caused in any manner by the goods or the use of the goods, including any expenses and attorney's fees in connection with all claims, demands, proceedings, or other expenses.

Any description of the goods contained in any documents to which these warranty provisions relate, including any quotations or purchase orders relating to the goods being delivered to the buyer, are for the sole purpose of identifying the goods, and any such description, as well as any sample or model which may have been displayed to or seen by the buyer at any time, have not been made part of the basis of the bargain and have not created or amounted to any express warranty that the goods would conform to any such description or any such sample or model.

**NEUTRONICS DOES NOT WARRANT THAT THE GOODS ARE FREE OF THE RIGHTFUL CLAIM OF ANY THIRD PERSON BY THE WAY OF INFRINGEMENT OF PATENT OR OTHER PROPRIETARY INFORMATION AND DISCLAIMS ANY WARRANTY AGAINST SUCH INFRINGEMENT.**

It shall be the responsibility of the buyer to read carefully and abide by all instructions provided to the buyer in the instruction manual or elsewhere. If the buyer, or the employees of the buyer, did not abide by such instructions, then the alleged defect shall not be deemed to have arisen under circumstances of proper use.

The terms of these warranty provisions shall apply to all products sold by Neutronics, except filters which are considered "consumable items," and as such are not covered by the terms of these warranties. No waiver, alteration or modification of the terms of these provisions shall be valid unless in writing and signed by an executive officer of NEUTRONICS.

**EXCEPT AS SPECIFICALLY SET FORTH AND LIMITED IN THIS PARAGRAPH, NEUTRONICS, INC. MAKES NO WARRANTIES, EXPRESSED OR IMPLIED, INCLUDING WARRANTIES AS TO MERCHANTABILITY, OR AS TO THE FITNESS OF THE GOODS FOR ANY PARTICULAR USE OR PURPOSE, AND ANY WARRANTIES SET FORTH IN THIS PARAGRAPH ARE IN LIEU OF SUCH IMPLIED WARRANTIES OF MERCHANTABILITY AND FITNESS FOR PARTICULAR USE OR PURPOSE.**